

# artex

## User guide



Model:  
W195TS  
W215TS  
W249TS

# CONTENTS

---

General Safety	4
Installation	8
Controls and Connections	10
Remote Control	12
Initial Setup	14
Smart Home	16
USB Media	19
Menu	
Picture	21
Sound	22
Programme	23
Connection	24
General	25
Accessibility	26
Support	27
FAQs	28

---

# Introduction

Thank you for purchasing this **AVTEX TV**

Please take time to read these instructions and retain for future reference.

## Safety is important

---

To ensure your safety and the safety of others, please read the Safety precautions **before** you operate this product.

## In the box

---

You will find the following:

- LED television
- User guide
- Quick start guide
- Remote control
- 2 x AAA batteries
- Power adapter
- Power cord
- 12 Volt DC lead

# Safety information

## Important safety instructions - read carefully before use

Take note of the following safety information which appears on the back of this TV.



**Caution! Risk of electric shock do not open. To reduce the risk of electric shock do not remove this cover. No user-removable parts inside. Refer servicing to qualified personnel.**



This symbol indicates that there are important operating and maintenance instructions in the literature accompanying this TV.



This symbol indicates that dangerous voltage constituting a risk of electric shock is present within this TV.

## WARNING

- Do not use this TV near water.
- Do not install or operate near any heat sources such as radiators, stoves, or other apparatus that produce heat.
- Clean only with a slightly damp cloth.
- Do not block any ventilation openings.
- Install in accordance with the supplied Quick start guide and this User guide.
- Protect the power cord from being walked on or pinched, particularly at plugs, and the point where it exits from the TV.
- Do not allow the power cord to overhang the edge of a table.
- Unplug this TV during lightning storms or when unused for long periods of time.
- To avoid interference, switch this TV off while operating other radio devices in the immediate vicinity.
- Refer all servicing to qualified service personnel. Servicing is required when the TV has been damaged in any way.

- No naked flame sources such as candles should be placed on the TV.

## Electrical information

### Mains supply

The mains operating voltage is detailed on the rating plate on the rear of the TV.



# Instruction

This equipment has been designed and manufactured to meet international safety standards but, like any electrical equipment, care must be taken if you are to obtain the best results and safety is to be assured.

DO read the operating instructions before you attempt to use the equipment.

DO ensure that all electrical connections (including the mains plug, extension leads and interconnections between the pieces of equipment) are properly made and in accordance with the manufacturer's

instructions. Switch off and withdraw the mains plug before making or changing connections.

DO consult your dealer if you are ever in doubt about the installation, operation or safety of your equipment.

DO route the mains lead so that it is not likely to be walked on, crushed, chafed, or subject to excessive wear and tear or heat.

DON'T remove any fixed cover as this may expose dangerous voltages.

DON'T obstruct the ventilation openings of the equipment with items such as newspaper, tablecloths, curtains, etc. Overheating will cause damage and shorten the life of the equipment.

DON'T allow electrical equipment to be exposed to dripping or splashing, or objects filled with liquids.

DON'T place hot object or naked flame sources such as lighted candles or night-lights on, or close to equipment. High temperatures can melt plastic and lead to fires.

DON'T use makeshift stands and NEVER fix legs with wood screws-to ensure complete safety always fit the manufacturer's approved stand or legs with the fixings provided according to the instructions.

DON'T use equipment so that you are distracted from the requirements of traffic safety.

DON'T listen to headphones at high volume, as such use can permanently damage your hearing.

DON'T leave equipment switched on when it is unattended unless it is specifically stated that it is designed for unattended operation or has a stand-by mode. Switch off by unplugging the equipment and make sure that your family know how to do this.

Special arrangements may need to be made for infirm or handi-capped people.

DON'T continue to operate the equipment if you are in any doubt about it working normally, or if it is damaged in any way-switch off, withdraw the mains plug and consult your dealer.

ABOVE ALL ,

- NEVER let anyone especially children push anything into holes, slots or any other opening in the equipment - this could result in a fatal electrical shock;

- NEVER guess or take chances with electrical equipment of any kind. It is better to be safe than sorry !

# Battery safety guidelines

Used correctly, domestic batteries are a safe and dependable source of portable power. Problems can occur if they are misused or abused- resulting in leakage or, in extreme cases, fire or explosion. Here are some simple guidelines to safe battery use designed to eliminate any such problems.



Take care to fit your batteries correctly, observing the plus and minus marks on the battery and appliance. Incorrect fitting can cause leakage or, in extreme case, fire or even an explosion.

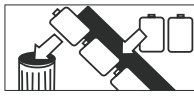

Replace the whole set of batteries at one time, taking care not to mix old and new batteries or different types, since this can result in leakage or, in extreme cases, fire or even an explosion.



Supervise children if they are replacing batteries themselves in order to ensure these guidelines are followed.



Store unused batteries in their packaging and away from metal objects which may cause a short-circuit, resulting in leakage or, in extreme cases, fire or even an explosion.



Remove dead batteries from the unit and all batteries from the unit you know you are not going to use for a long time. Otherwise the batteries may leak and cause damage.



Make sure battery compartments are secure.

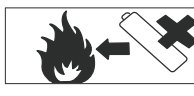

Never dispose of batteries in fire as this can cause them to explode. Please recycle dead batteries; do not put with the normal household waste.



Never attempt to recharge ordinary batteries, either in a charger or by applying heat to them. They may leak, cause fire or even explode. There are special rechargeable batteries which are clearly marked as such.

# Safety warnings

## Use in a vehicle

### Note

For use only when vehicle is Stationar.

- Read all the instructions carefully before using the unit and keep them for future reference.
- Retain the manual. If you pass the unit onto a third party make sure to include this manual. Check that the voltage marked on the rating label matches your mains voltage.

## Damage

- Inspect the unit for damage after unpacking.
- Do not continue to operate the unit if you are in any doubt about it working normally, or if it is damaged in any way-switch off, withdraw the mains plug and consult your dealer.

## Location of Unit

- The unit must be placed on a flat stable surface and should not be subjected to vibrations.
- Do not place the unit on sloped or unstable surfaces as the unit may fall off or tip over.
- The mains socket must be located near the unit and should be easily accessible.

## Temperature

- Avoid extreme degrees of temperature, either hot or cold. Place the unit well away from heat sources, such as radiators or gas/electric fires.
- Avoid exposure to direct sunlight and other sources of heat.

## Naked Flames

- Never place any type of candle or naked flame on the top of or near the unit.

## Moisture

- To reduce the risk of fire, electric shock or product damage, do not expose this unit to rain, moisture, dripping or splashing. No objects filled with liquids, should be placed on the unit.
- If you spill any liquid into the unit, it can cause serious damages. Switch it off at the mains immediately. Withdraw the mains plug and consult your dealer.

## Ventilation

- To prevent the risk of electric shock or fire hazard due to overheating, ensure that curtains and other materials do not obstruct the ventilations.
- Do not install or place this unit in a bookcase, built-in cabinet or in another confined space. Ensure the unit is well ventilated.

## Safety

- Always disconnect the unit from the mains supply before connecting /disconnecting other devices or moving the unit.
- Unplug the unit from the mains socket before a lightning storm.

## Mains Cable

- Make sure the unit or the unit stand is not resting on top of the mains cable, as the weight of the unit may damage the cable and create a safety hazard.

## Interference

- Do not place the unit on or near appliances which may cause electromagnetic interference. If you do, it may adversely affect the operating performance of the unit, and cause a distorted picture or sound.

# Safety warnings

## Batteries

- Batteries used in the remote control for this unit are easily swallowed by young children and this is dangerous.
- Keep loose batteries away from young children and make sure that the battery holder tray is secure in the remote control. Seek medical advice if you believe a cell has been swallowed.
- Dispose of batteries correctly by following the guidance in this manual.

## Supervision

- Children should be supervised to ensure that they do not play with the unit and the remote control.
- Never let anyone especially children push anything into the holes, slots or any other openings in the case -this could result in a fatal electric shock.

## Service

- To reduce the risk of electric shock, do not remove screws. The unit does not contain any user-serviceable parts. Leave all maintenance work to qualified personnel.
- Do not open any fixed covers as this may expose dangerous voltages.

## Maintenance

- Ensure the unit is fully unplugged from the power supply before cleaning.
- Do not use any type of abrasive pad or abrasive cleaning solutions as these may damage the unit's surface.
- Do not use liquids to clean the unit.



**Warning! To reduce the risk of fire or electrical shock, do not expose this TV to rain or moisture. The TV must not be exposed to dripping and splashing and no objects filled with liquids such as a vase of flowers should be placed on the TV.**



**Caution! Changes or modifications not expressly approved by the manufacturer could void the user's warranty.**

**Caution! Usage of controls or adjustments or performance of procedures other than those specified herein may result in hazardous exposure.**

The power cord on this equipment is supplied with a moulded plug incorporating a fuse. Should the fuse need to be replaced, an ASTA or BSI approved BS1362 fuse must be used of the same rating. Never use the plug with the fuse cover removed. If a replacement fuse cover is required, ensure it is of the same colour as that visible on the pin face of the plug. If there is no alternative to cutting off the mains plug, dispose of it immediately, having first removed the fuse, to avoid a possible shock hazard by inadvertent connection to the mains supply.



The lightning flash with arrowhead symbol, within an equilateral triangle, is intended to alert the user to the presence of uninsulated "dangerous voltage" within the unit's enclosure that may be sufficient magnitude to constitute a risk of electric shock.



The exclamation point within an equilateral triangle is intended to alert the user to the presence of important operating and maintenance (servicing) instructions in the manual accompanying the unit.

# Parts identification

## Front, side and above views

---

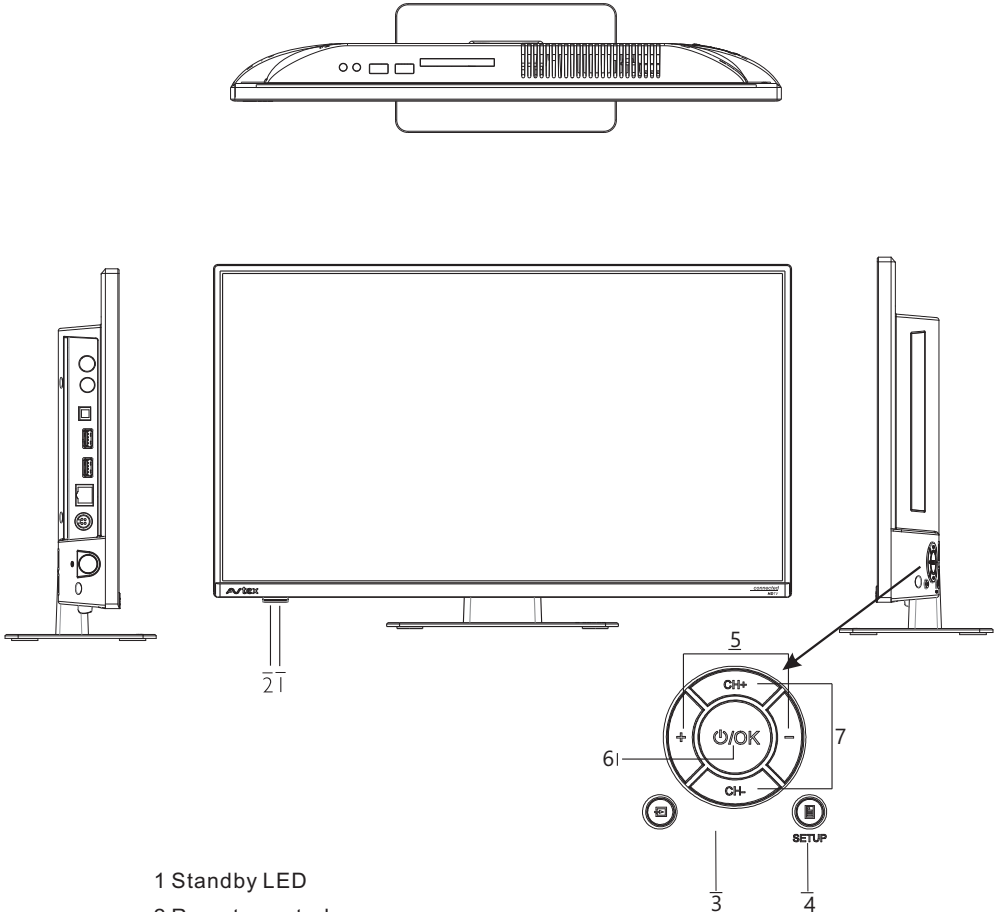

- 1 Standby LED
- 2 Remote control sensor
- 3 SOURCE                      Accesses the SOURCE menu
- 4 SETUP                        Enter or exit setup menu
- 5 VOL+/-                      Increases / Decreases the volume
- 6  $\text{P}/\text{OK}$                       TV standby mode
- 7 CH+/-                        Increases / Decreases the channel number

# Parts identification

## Rear view

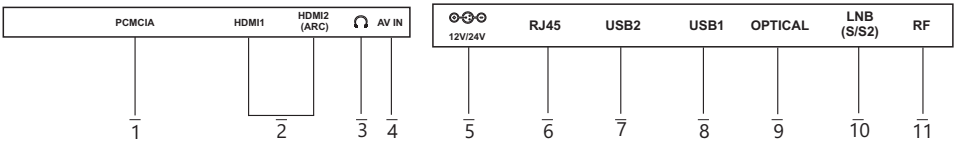
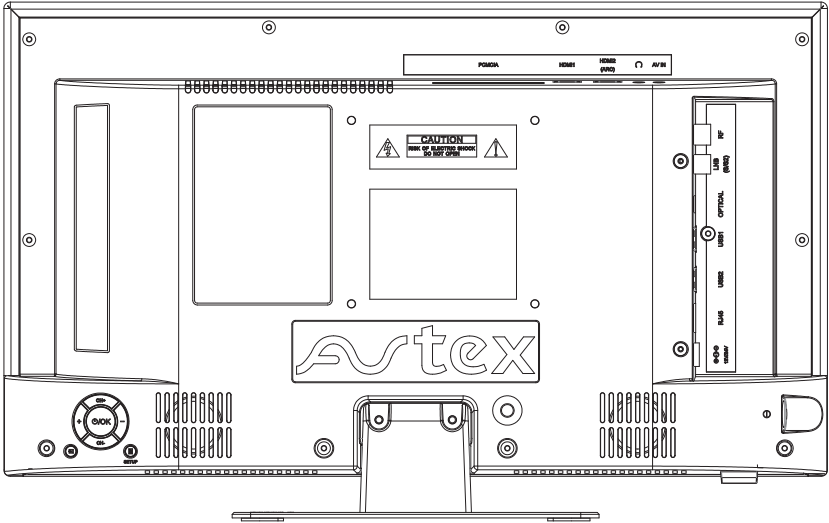

- 1 PCMCIA CARD SLOTS FOR EXTERNAL CONDITIONAL ACCESS(CA)-MODULES.
- 2 HDMI1/HDMI2(ARC) IN SOCKET. REFER TO HDMI PAGE
- 3 HEADPHONE OUTPUT TERMINAL
- 4 AV INPUT
- 5 12V/24V DC INPUT TERMINAL
- 6 RJ45 INTERNET INPUT
- 7 USB2
- 8 USB1
- 9 OPTICAL AUDIO OUT
- 10 LNB S/S2 TERMINAL
- 11 RF INPUT TERMINAL(AERIAL)

# REMOTE CONTROL



**POWER:** ON/OFF.

**TV/RAD:** Switch to TV or Radio.

🔍 : Search.

**SUBTITLE:** Enable/disable subtitles.

⚙️ : Enters the Quick Settings menu.

📺 : Selects an input source.

0-9: Number selection key.

**LIST:** The QUICK ACCESS edit screen appears.

⋮ : It displays the additional buttons on the remote control.

🔊 : It adjusts the volume level.

📺 : You can change the programme.

**AD:** Turn the AD switch on or off.

**GUIDE:** You can check the programme.

🔇 : Mutes the sound.

▶️ : Play.

🏠 : Displays the Home menu.

⏸️ : Pause.

**BACK :** Move to the previous step.

**EXIT:** Closes the menu.

⊙ : Select current option that's highlighted.

⬅️⬆️⬇️⬆️➡️ : RIGHT/LEFT UP/DOWN buttons to navigate the on-screen menus.

**TEXT:** Open the TEXT.

**T.OPT:** Open the function menu of TEXT.

**MOVIES:** Search Movies

**REC:** Launch Record.

📺 : Launch Live Playback.

**NETFLIX:** go to Netflix.

**prime video:** go to prime video.

🔴 🟢 🟡 🔵 : Corresponds to various colour functions in the menu or teletext.

**Universal Remote Control Code: 40BF**

# Remote control

## Remote control

---

### Installing the batteries

1. The battery compartment cover is on the back of the remote control. Slide the cover to open it.
2. Install the two AAA size batteries following the polarity markings inside the compartment.
3. Replace the battery compartment cover.

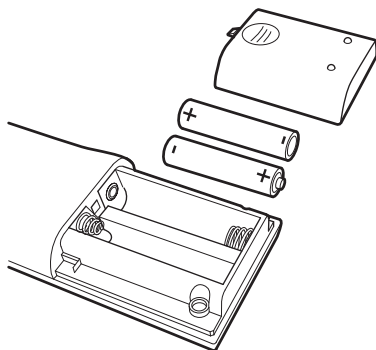

## Using the remote control

---

To use the remote control point it at the TV and press the required buttons. You must be within 6 metres and at an angle of less than 30 degrees from the centre of the TV.

**Note:** Sunshine or other strong light sources may interfere with the signal from the remote control. In this situation, turn the TV set away from the light source.

---

**Warning!** Do not leave batteries in the remote control for extended periods as they can leak or corrode causing damage to the remote control. Check them periodically and replace them as required.

---

**Warning!** Do not mix battery types. When inserting batteries, replace all batteries at the same time. Do not mix old and new batteries.

---

**Warning!** Exhausted batteries must be treated with care and disposed of according to any safety or recycling regulations in force in your local area. Never dispose of batteries into general waste, or fire.



---



# INITIAL SETUP

## Source Selection

Press (  ) button to display the input source list.

Press  /  button to select the input source you want to watch, then press the (  ) button to enter the input source. HDMI input source needs to be selected in Home Dashboard.

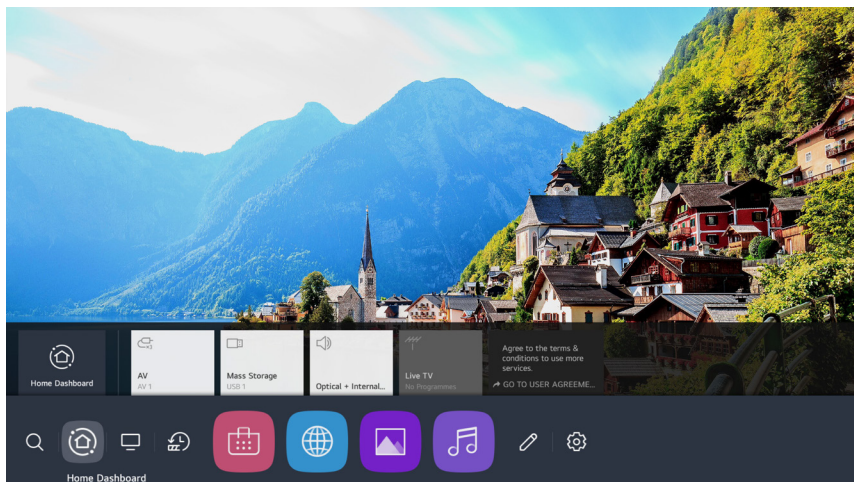



Note: Before watching please make sure all necessary cables and devices are connected.

# INITIAL SETUP (CONT.)

## Quick Settings

Press the (  ) button on the remote control, the screen will display a quick setting menu, such as picture mode, sound mode, sleep timer, etc.

You can add/delete the quick setting items or change their order. After entering each item, press the (  ) button on the remote control to go to the corresponding menu. Press  /  button to select the option.

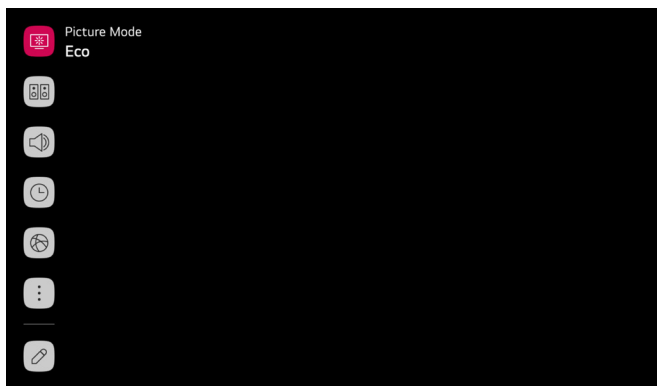

## Using Live Menu

You can use the relevant features with ease when watching TV broadcasts. Press the LIST button on the remote control.



1. Programmes: View a list of broadcast content that is currently being broadcast.
2. Guide: You can view programmes and the schedule of each programmes.
3. TV Scheduler: You can enter the time and date of a programme to schedule watching or recording it at the set time.

# SMART HOME

## Home Tutorial

Using the home feature of the webOS TV

You can open the home screen by pressing the **HOME** button on your remote control.

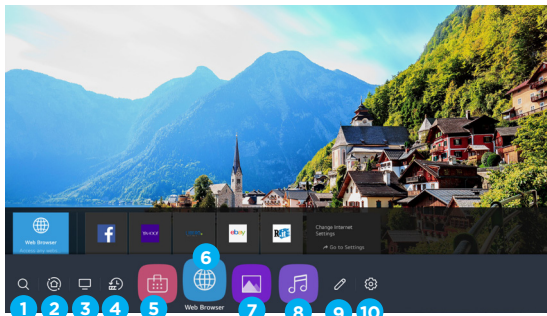

1. Enter the search menu. Search for a variety of content and information using the desired search terms. Need to make sure the network connection is normal
2. Move To The Home Dashboard.
3. Move to the TV input you used recently.
4. Move to the recently used app.
5. Move to the the APP store.
6. Move to the Browser.
7. Move to the Picture and video playback menu.
8. Move to the Music playback menu.
9. Move to the Edit menu.
10. Move to the Settings menu.

## Manage Home

Manage webOS TV Home.

You can view a list of all apps installed on your TV, change their positions, or delete them.

You can perform the operations you want according to the prompt information on the TV screen.

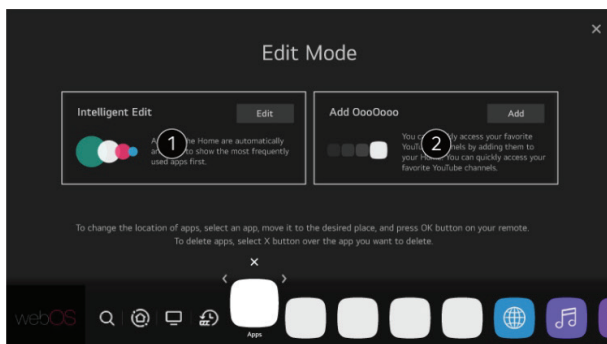

# SMART HOME (CONT.)

1. Select the app you want to edit, and press and hold the (Ⓞ) button on the remote control. This will activate the app edit mode.
2. To move the app to your desired position, go to the position and press the (Ⓞ) button. To delete an app, select the “X” icon above the app. You can move and delete as many apps as you wish before exiting the edit mode. You can also move apps with the buttons ◀/▶ on your remote control.
3. After the editing is done, press the “X” at the top right to exit the App Edit mode. The default TV app cannot be edited.

## Launching Apps through QUICK ACCESS

Press and hold a number button on the remote control to open an app or to activate an external input registered to the button.

### Setting QUICK ACCESS

1. Launch the app or select the programme or input you wish to assign.
2. Press and hold the number button (1-9) you want to register.
3. When the registration pop-up window appears, select Yes.

If you press and hold a number button that has already been registered, the registered function will be performed.

To see the items that can be registered, select a number that has not been registered in the QUICK ACCESS edit mode.

If you are in a mode where QUICK ACCESS cannot run, no action will be performed.

If you delete a registered app, QUICK ACCESS will be deregistered as well.

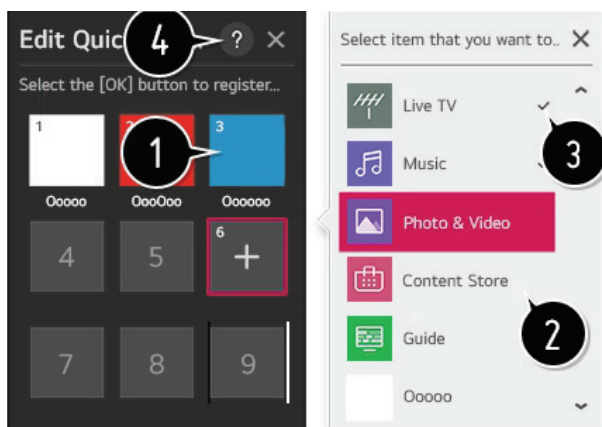

# SMART HOME (CONT.)

## Home Dashboard

You can select or control a device connected to the TV. Press the (  ) button on the remote control and select Home Dashboard.

You can perform the operations you want according to the prompt information on the TV screen.

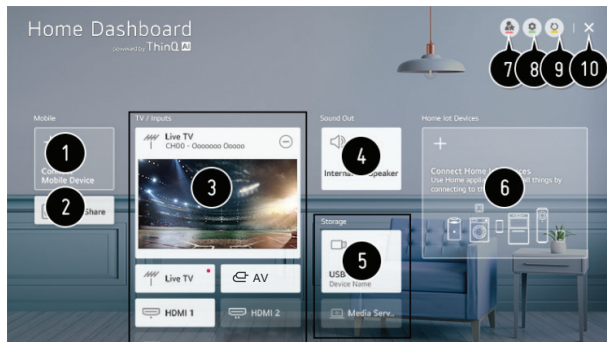

1. Check and select the smart device connected with the LG ThinQ app.
2. Play sound from a smart device connected via Bluetooth.
3. Check and select the external device connected through the external input port or network.
4. The currently selected output speaker is displayed, and you can navigate to the output speaker settings screen.
5. View and select the connected storage device.
6. Check and control the device connected via the Home IoT.
7. Easily control your device by presetting the desired operations.
8. Sign In : You can log in/out to and from the LG ThinQ account you created on mobile.  
Edit: You can edit the name of the device connected to Inputs or Home IoT Devices or configure the related settings.
9. Refreshes the device list.
10. Exit the Home Dashboard.

# USB MEDIA



## USB Media Player

Connect a USB storage device to the USB port on the TV to enjoy the content files stored on the USB storage device on your TV.

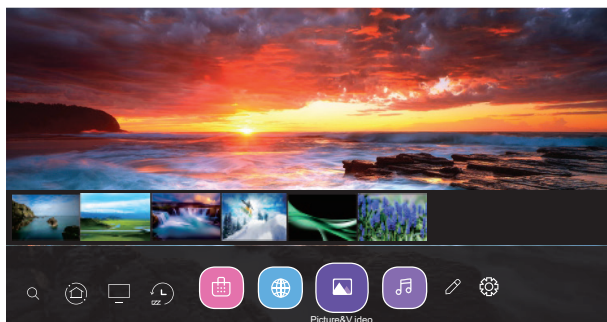
Support format: jpeg, jpg, jpe, png and bmp for photo, mp3, wav, ogg, wma, flac for music, asf, avi, mp4, 3gp, mkv, ts, mpg, vob for video.



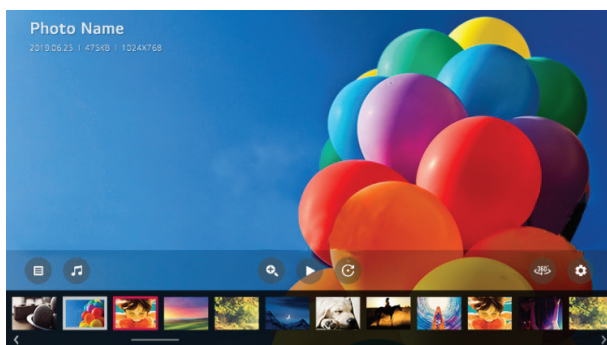

## Using Photo Player

Selecting Photo & Video app and press (  ) button to enter the menu. You can view your saved photos. Press Arrow buttons to select the file you want to watch in the file selecting menu, then press (  ) button to start playing. When playing media, press the (  ) button to display and operate file details.





# USB MEDIA (CONT.)

## Playing Video

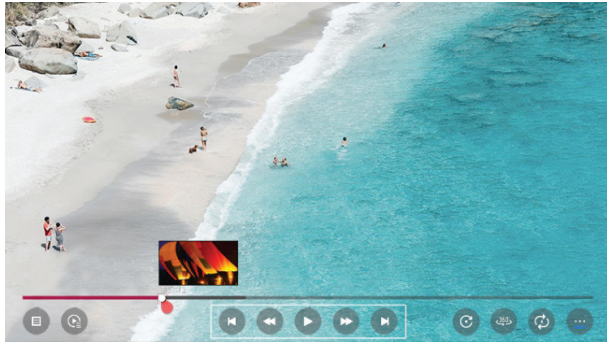
Selecting Photo & Video app and press (  ) button to enter the menu. You can view your saved videos. Press Arrow buttons to select the file you want to watch in the file selecting menu, then press (  ) button to start playing. When playing media, press the (  ) button to display and operate file details.



## Playing Music

Selecting Music app press (  ) button to enter the menu. You can listen your saved music. Press Arrow buttons to select the file you want to listen to music in the file selecting menu, then press (  ) button to start playing. When playing media, press the (  ) button to display and operate file details.



# MENU

## Picture Menu

Select All settings in settings menu, press (  ) button to enter the submenu.

Press **▲/▼** buttons to select **Picture** in the submenu, it will highlight the option, then press **▶** button to enter menu.

Press **▲/▼** button to select the option and press (  ) button to enter the submenu.



### Picture Mode Settings

Select a video mode that matches the viewing environment, or specify settings for a video mode, such as contrast, color and more.

### Aspect Ratio Settings

View the original screen as it is or set the screen size and aspect ratio.

### Energy Saving

Energy saving modes to limit power consumption. Adjust screen brightness to reduce energy consumption.

If you use Energy Saving function, brightness of your TV will be affected.

### Additional Settings

Set additional picture settings. Include Eye Comfort Mode, HDMI Ultra HD Deep Color and Instant Game Response.



# MENU (CONT.)

## Sound Menu

Select All settings in settings menu, press (  ) button to enter the submenu.

Press **▲/▼** buttons to select **Sound** in the submenu, it will highlight the option, then press **▶** button to enter menu.

Press **▲/▼** button to select the option and press (  ) button to enter the submenu.

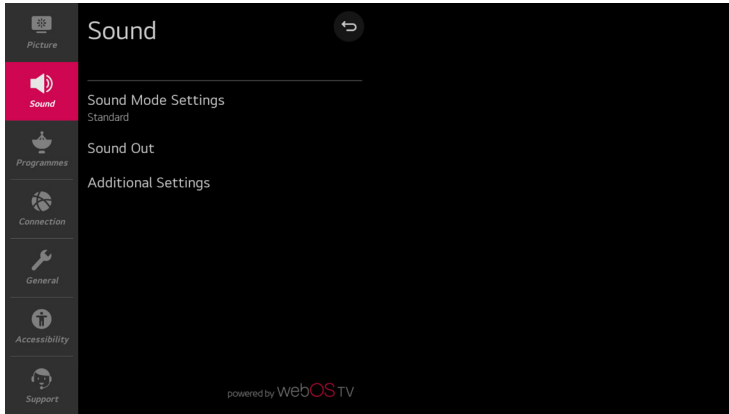

### Sound Mode Settings

Select the Sound mode and set detailed Audio effects. This settings is only available for Internal TV Speaker. Include Standard, Cinema, Clear Voice III, Sports, Music and Game.

### Sound Out

Select device or speaker for audio output. Include Internal TV Speaker, Bluetooth, Mobile Device, Optical, HDMI ARC, Wired Headphones, Optical + Internal TV Speaker etc. for your choice.



### Additional Settings



Set additional sound-related settings. Include TV Installation Type, Volume Mode, AV Sync Adjustment, HDMI Input Audio Format, LG Sound Sync and Digital Sound Out for your choice. You can perform the operations you want according to the prompt information on the TV screen.

# MENU (CONT.)

## Programmes Menu

Select All settings in settings menu, press (  ) button to enter the submenu.

Press  /  buttons to select **Programmes** in the submenu, it will highlight the option, then press  button to enter menu.

Press  /  button to select the option and press (  ) button to enter the submenu.

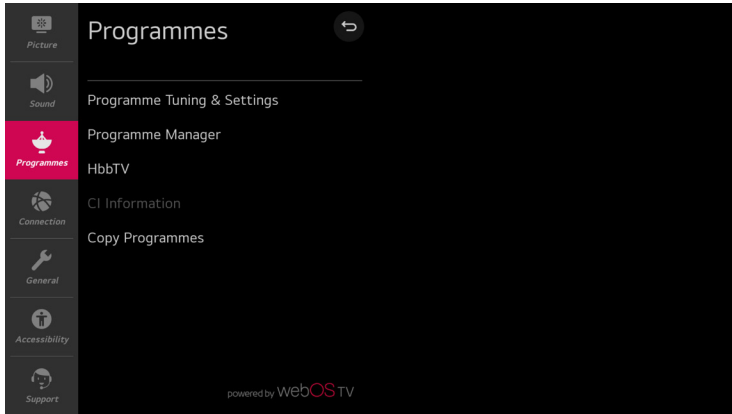

### Programme Tuning & Settings

Tune and save available programmes.

You can set satellite programme options.

### Programme Manager

Manage programmes stored on the TV.

### HbbTV

This service provides you with more information about watching programme and enjoys related contents.

### CI Information

View current Common Interface ( CI ) information.

### Copy Programmes



Import / export your TV's programme list information from / to a connected USB device.

Note: Available options depend on the broadcast program.

# MENU (CONT.)

## Connection Menu

Select All settings in settings menu, press (  ) button to enter the submenu.

Press  /  buttons to select **Connection** in the submenu, it will highlight the option, then press  button to enter menu.

Press  /  button to select the option and press (  ) button to enter the submenu.

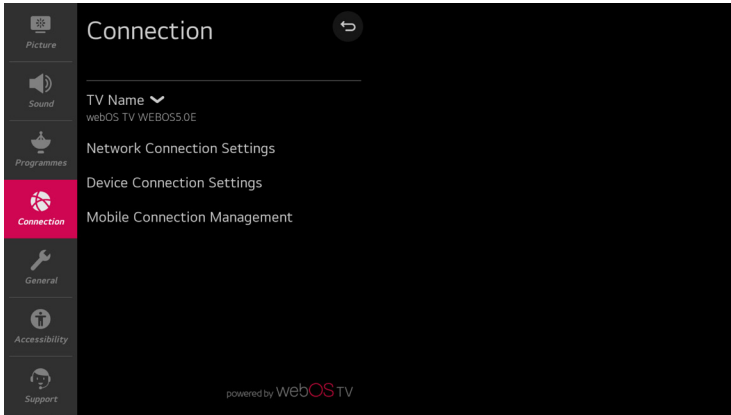

### TV Name

Set the TV name.

### Network Connection Settings

Set settings related to your wired / wireless network.

### Device Connection Settings

Set easy connection settings with external devices. After entering the menu, you can select and set these options of Auto Device Detection, SIMPLINK (HDMI-CEC), Auto Power Sync, LG Wireless , Keyboard and Universal Control Settings.

### Mobile Connection Management

Connection Management with a smartphone or PC is available. In order to connect a TV with a mobile device, connection settings and requests are required on the smartphone and PC.

# MENU (CONT.)

## General Menu

Select All settings in settings menu, press (  ) button to enter the submenu.

Press **▲/▼** buttons to select **General** in the submenu, it will highlight the option, then press **▶** button to enter menu.

Press **▲/▼** button to select the option and press (  ) button to enter the submenu.

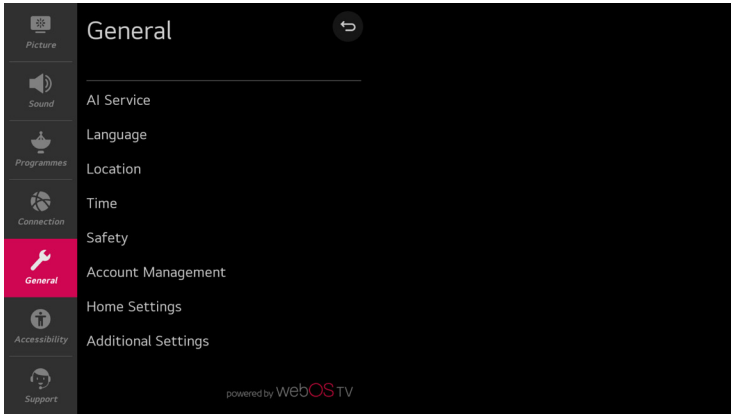

### AI Service

Set detailed options for the AI functions.

### Language

Select TV's language settings. You can set the Menu Language, Audio Language and Keyboard Languages.

### Location

Set the region and country for broadcasts and special services.

### Time

Set the current date and time. If the time you set is much different from the current time, some of the smart features may not be displayed. Include Time, date and Time Zone.

### Safety

Set locking on the specified channels, apps, inputs and etc to use under parents guidance.

### Account Management

Set up an account to use Services.

### Home Settings

Set detailed options for the Home feature.

### Additional Settings

Set the additional functions related to the TV.

# MENU (CONT.)

## Accessibility Menu

Select All settings in settings menu, press (  ) button to enter the submenu.

Press **▲/▼** buttons to select **Accessibility** in the submenu, it will highlight the option, then press **▶** button to enter menu.

Press **▲/▼** button to select the option and press (  ) button to enter the submenu.

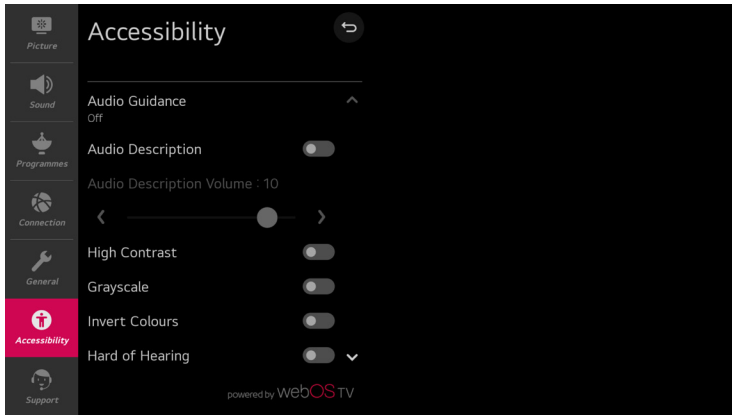

### Audio Guidance

Guide menus and operations with voice for visually impaired viewers to use TV. Specify detailed voice guidance settings after turning on this feature.

### Audio Description

Alerts you by sound when the TV is turned on or off. The sound may not be output when digital sound output is set to Pass Through.

### High Contrast

Enhance the contrast between bright and dark areas of some menus, such as the background and text, for being easily viewed by those with low-vision.

### Grayscale

Change the color of the menu on the screen to black and white tone for higher clarity.

### Invert Colors

Invert and compensate certain colors in some menus to enhance the visibility of items displayed on the screen.

### Hard of Hearing

Display captions for hearingimpaired viewers to use TV.

It works only when thebroadcasting programmesupports subtitles.

# MENU (CONT.)

## Support Menu

Select All settings in settings menu, press (  ) button to enter the submenu.

Press **▲/▼** buttons to select **Support** in the submenu, it will highlight the option, then press **▶** button to enter menu.

Press **▲/▼** button to select the option and press (  ) button to enter the submenu.

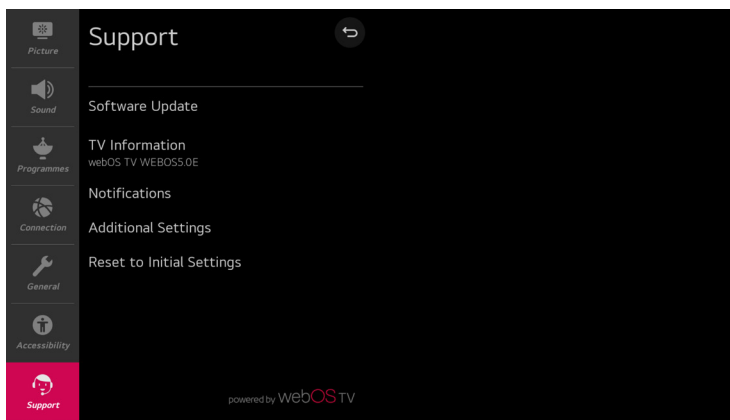

### Software Update

Check for software updates and update if available.

### TV Information

Check TV information.

### Notifications

Check alarm messages about the user settings or TV status.

### Additional Settings

Set up additional features related to customer support. Include User Agreements, Legal Notice and Open Source Software Notice These options.

### Reset to Initial Settings

Revert TV to its initial settings. This will revert all options on TV to their default settings.

# Specifications

Specifications of the TV that you have just purchased may vary from the information in this table due to technical innovations.

Operation System	Power by webOS	5.0
Panel	Type: Size: Display size(mm): Pixel pitch(mm): Response time(ms): Brightness(cd/m2): Contrast ratio: Viewing angel(H): Viewing angle(V): Panel life(hours):	LED panel 19.5" 434.88(H)x238.68(V) 0.2265(H)x0.221(V) 20ms 250 3000:1 178 178 50000
Frequency	Vertical: Horizontal: Display colour:	Frame rate:50~75Hz 30~75Hz 16.7 Million colours
Display Mode	Optimum mode:	1920x1080; 75Hz
Inputs	Mini AV: USB: HDMI: Onboard dual band Wi-Fi antenna Ethernet	1 2 2 2.4 Ghz and 5 Ghz bands 10/100 Mbit/s
Outputs	Audio Headphone: Optical	1 1 1
Colour systems	Video inputs:	PAL, SECAM, NTSC 3.58, NTSC 4.43, PAL60
Power adapter	Input Output	100V-240V~, 50/60 Hz ⏚12V, 3.3A
Power	Normal: Standby:	28W < 0.5W
Environmental consideration	Operating temperature Operating humidity: Storage temperature: Storage humidity:	+ 5°C...+ 35°C 10~80% -20°C...+45°C 5%~95%
DTV	Input connector Frequency range(VHF/UHF): Channel range(VHF/UHF):	IEC-Type, IEC I69.2, Female 474~858MHz 8MHz
SAT TV	Input interface: Frequency scope: Input level: Input impedance:	F-Type 950-2150MHz -65-25dbm 75
Dimensions(WxHxD)		448.9mmx278.2mmx46.2mm
Net weight		2.5kg

# Specifications

Specifications of the TV that you have just purchased may vary from the information in this table due to technical innovations.

Operation System	Power by webOS	5.0
Panel	Type: Size: Display size(mm): Pixel pitch(mm): Response time(ms): Brightness(cd/m2): Contrast ratio: Viewing angel(H): Viewing angle(V): Panel life(hours):	LED panel 21.5" 476.064(H)x267.786(V) 0.24795(H)x0.24795(V) 25ms 250 3000:1 178 178 50000
Frequency	Vertical: Horizontal: Display colour:	Frame rate:50~75Hz 30~75Hz 16.7 Million colours
Display Mode	Optimum mode:	1920x1080; 75Hz
Inputs	Mini AV: USB: HDMI: Onboard dual band Wi-Fi antenna Ethernet	1 2 2 2.4 Ghz and 5 Ghz bands 10/100 Mbit/s
Outputs	Audio Headphone: Optical	1 1 1
Colour systems	Video inputs:	PAL, SECAM, NTSC 3.58, NTSC 4.43, PAL60
Power adapter	Input Output	100V-240V~, 50/60 Hz ⏚12V, 3.3A
Power	Normal: Standby:	30W < 0.5W
Environmental consideration	Operating temperature Operating humidity: Storage temperature: Storage humidity:	+ 5°C...+ 35°C 10~80% -20°C...+45°C 5%~95%
DTV	Input connector Frequency range(VHF/UHF): Channel range(VHF/UHF):	IEC-Type, IEC I69.2, Female 474~858MHz 8MHz
SAT TV	Input interface: Frequency scope: Input level: Input impedance:	F-Type 950-2150MHz -65-25dbm 75
Dimensions(WxHxD)		491.9mmx308.2mmx46.2mm
Net weight		2.9kg



# Specifications

Specifications of the TV that you have just purchased may vary from the information in this table due to technical innovations.

Operation System	Power by webOS	5.0
Panel	Type: Size: Display size(mm): Pixel pitch(mm): Response time(ms): Brightness(cd/m2): Contrast ratio: Viewing angel(H): Viewing angle(V): Panel life(hours):	LED panel 23.8" 527.04(H)x299.46(V) 0.2265(H)x0.221(V) 15ms 250 3000:1 178 178 50000
Frequency	Vertical: Horizontal: Display colour:	Frame rate:50~75Hz 30~75Hz 16.7 Million colours
Display Mode	Optimum mode:	1920x1080; 75Hz
Inputs	Mini AV: USB: HDMI: Onboard dual band Wi-Fi antenna Ethernet	1 2 2 2.4 Ghz and 5 Ghz bands 10/100 Mbit/s
Outputs	Audio Headphone: Optical	1 1 1
Colour systems	Video inputs:	PAL, SECAM, NTSC 3.58, NTSC 4.43, PAL60
Power adapter	Input Output	100V-240V~, 50/60 Hz ⏏12V, 3.3A
Power	Normal: Standby:	33W < 0.5W
Environmental consideration	Operating temperature Operating humidity: Storage temperature: Storage humidity:	+ 5°C...+ 35°C 10~80% -20°C...+45°C 5%~95%
DTV	Input connector Frequency range(VHF/UHF): Channel range(VHF/UHF):	IEC-Type, IEC I 69.2, Female 474~858MHz 8MHz
SAT TV	Input interface: Frequency scope: Input level: Input impedance:	F-Type 950-2150MHz -65-25dbm 75
Dimensions(WxHxD)		539.4mmx336.4mmx47.4mm
Net weight		3.4kg

# Care and maintenance

## Disposal

This symbol  on the product or on its packaging indicates that this product may not be treated as household waste. Instead it shall be handed over to the applicable collection point for the recycling of electrical and electronic equipment. By ensuring this product is disposed of correctly, you will help prevent potential negative consequences for the environment and human health, which could otherwise be caused by inappropriate waste handling of this product. For more detailed information about recycling of this product, please contact your local council office, your household waste disposal service.

## Guarantee

Your AVTEX television is covered by a 3 year parts and labour guarantee. This means that if the television develops a fault during the guarantee period we arrange a repair free of charge. Your original receipt acts as your guarantee so please make sure that you retain it throughout the guarantee period.

Please note that this guarantee does not cover you against faults caused by accidental damage or misuse.

This does not effect your statutory rights.

## Manufacturer

### **Avtex Limited**

Calon Point  
No.1 Fountain Lane  
St.Mellons Business Park  
Cardiff  
CF30 FE  
United Kingdom